

Vaillant Training/Logical Fault Finding Guide for all COMBIcompact and THERMOcompact models

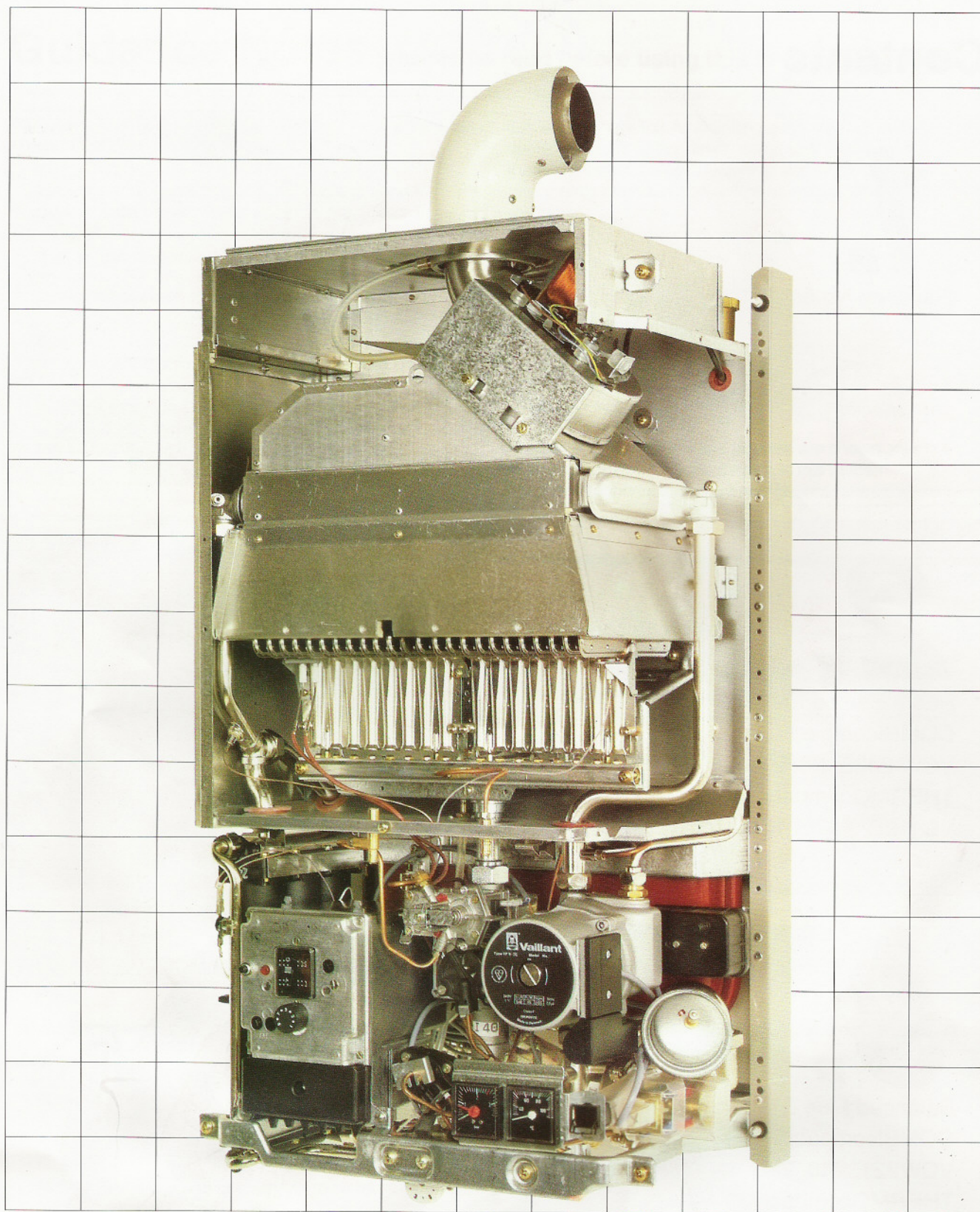

HEATING, CONTROLS, HOT WATER.

Contents

1.

Guidance Notes



2.

Room Sealed Fan Flued Models (RSF)
COMBIcompact
VCW 242E, 282E
THERMOcompact
VC112E, 142E, 182E, 242E, 282E

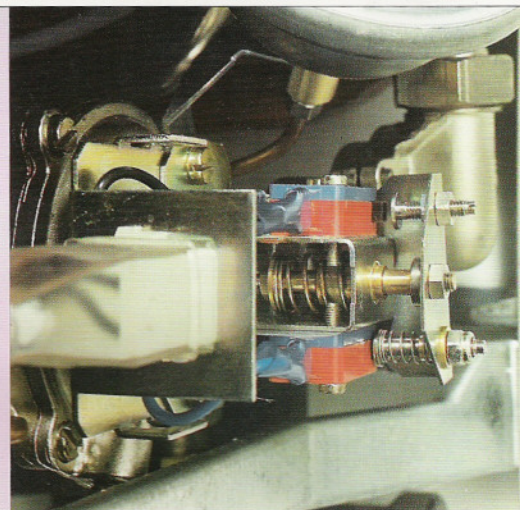

3.

Balanced Flue & Open Flue Models
COMBIcompact
VCW221, 240, 280
THERMOcompact
VC110, 180, 240, 221.

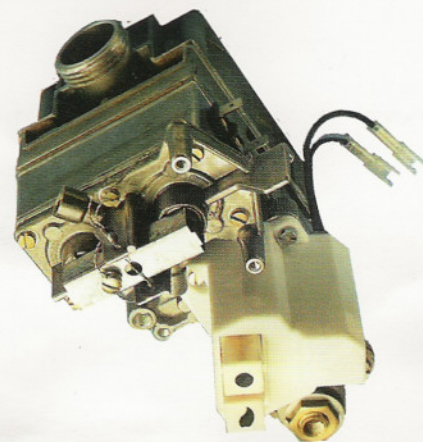

Guidance Notes (should be read before using this fault finding guide)

1. Check you are using correct guide for your appliance. See index and check model number.

2. Always start at the beginning of guide and work through one step at a time.

3. All guides deal with central heating (C/htg) first, then hot water (D.H.W.)

Do the same when following guides.

4. When checking 240v AC mains voltage use terminal 1 on appliance terminal strip as the neutral test point.

5. When checking D.C. voltage use terminal 9 on appliance terminal strip as the negative test point. (All D.C. voltages are low voltage).

6. In order to use this fault finding guide ensure that the operating mode of circulating pump is set to operating mode (I) (selector plug adjacent to appliance terminal strip makes electrical connection to contact one) see diagram.

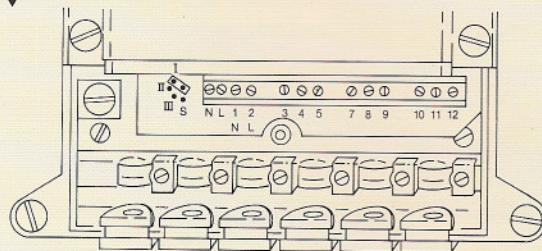

7. Note that illustrations and pictures are shown only once and are not duplicated again in this guide. Each illustration/picture has been given a reference number.

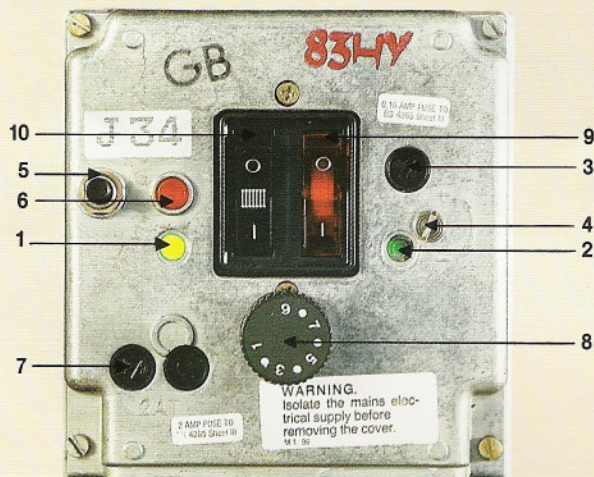

FRONT CONTROL PANEL

Key

1. Yellow neon indicating power to operator.
2. Green neon indicating operation of Diaphragm pump. As voltage decreases to diaphragm pump so neon loses luminosity.
3. 0.16 amp anti surge fuse.
4. Time delay adjustment (factory set 5 minutes, adjustable 1-12 minutes).
5. Fault suppression button (ignition lockout).
6. Indicating neon (lockout).
7. 2 x 2 amp fuses (L&N).
8. Variable potentiometer controlling central heating flow temperature only.
9. Red neon rocker switch for power on.
10. Central heating rocker switch (not fitted on VC appliances).

Note 1 It is law* that any work carried out on a gas appliance must be carried out by a competent person who is registered with CORGI (Council for Registered Gas Installers).

Note 2 All work involving electricity must be carried out by a competent person who is responsible for electrical safety checks.

*Gas Safety (Installations and Use) Regulations 1984
 Gas Safety (Installations and Use) Amendment Regulation 1990

2

Room Sealed Fan Flued Models (RSF)

COMBIcompact VCW242E, 282E

THERMOcompact VC112E, 142E, 182E, 242E, 282E

Red Rocker Switch - Set to ON position

Heating Switch - Set to ON position (VCW only)

Circulating Pump - Operating mode position one (I) (See guidance note 6)

First check central heating operation (All external controls on)

1

Does red neon glow in main rocker switch ?

NO

YES

Go to 2

(a) Check 240v AC across terminals 2 (L) and 1 (N)

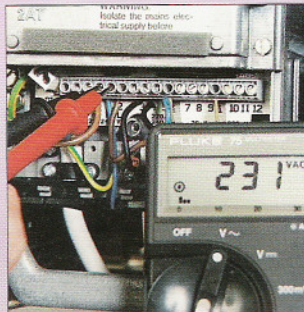

Pic 1

(b) Check 2 x 2 amp appliance fuses



Pic 2

(c) Check 3 amp spur fuse

If fuses OK and power available but neon fails to light, replace front Mother Board

2

Does fan run ?

→ NO →

YES

Go to 3

(a) If necessary reset black lockout button (front of control box).

Pic 3

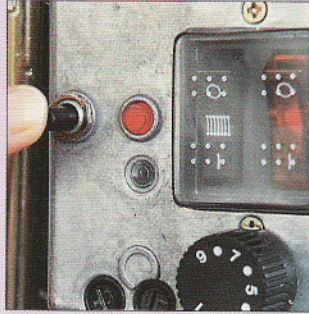

(b) Check variable potentiometer (boiler stat) setting on maximum.

(c) Check appliance not in time delay (isolate power, wait 5 seconds and restore).

(d) Check anti surge fuse (0.16 amp).

Pic 4



(e) Check/reset main heat exchanger overheat thermostat (should be 240v AC at terminal 3, if not reset button on black box by circulating pump).

Pic 5

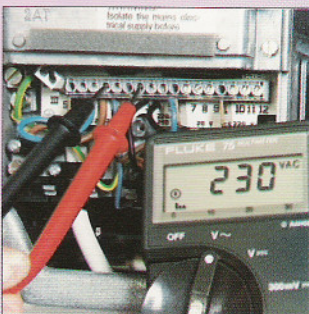

(f) Check demand for heating external controls on, and 240v AC back to terminal 4.

(g) Check 240v AC across fan motor (if yes change fan).

Pic 6



(h) Check domestic hot water overheat thermostat (VCW only) pull off bottom white wire, if fan then starts replace DHW overheat.

Pic 7



(i) Check NTC pull wire off NTC sensor if fan starts replace NTC.

Pic 8

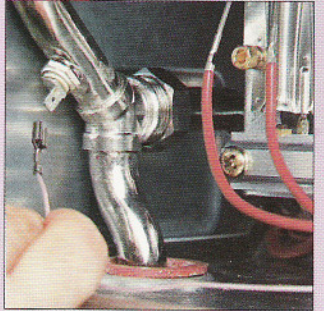

(j) Check safety isolating transformer 240v AC primary (black/grey) and approx. 17v AC secondary (brown/blue).

Pic 9

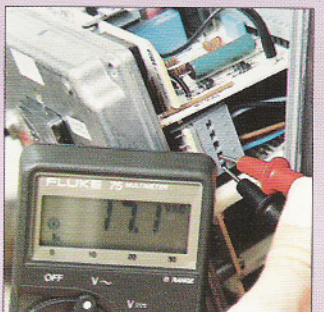

2

3

Does pump run ?

→ NO →

YES

Go to 4

(a) Check 240v AC across pump terminals

Pic 10



(b) Check pump free to rotate and not stuck

Pic 11

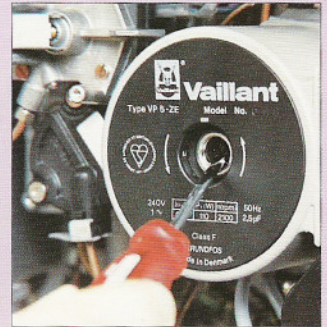

If (a) and (b) are OK - change pump.

4

Check hydraulic operation OK ?

1. Hydraulic diverter valve moves left closes microswitch M2 (VCW only)

→ NO →

Pic 13

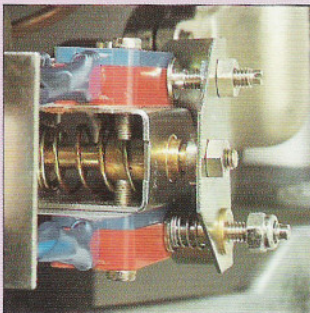

2. Differential valve opens.

Pic 14

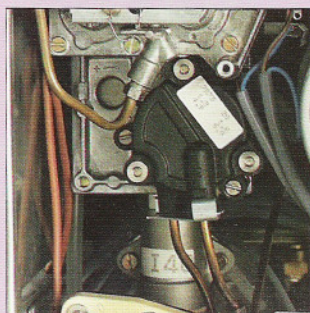

(a) Check appliance and system full, pressurised and vented of air.

(b) Check servo valve is in C/htg position, return spring holds cam down (VCW only).

Pic 12

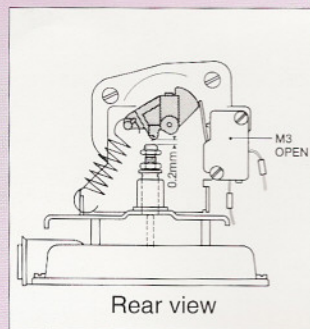

(c) Check for dirt, sludge, flux or inhibitor causing frothing in system affecting:-

1. Pump performance
2. Hydraulic diverter valve (VCW only)
3. Servo valve (VCW only)
4. Connecting tubes
5. Main heat exchanger
6. Differential valve

YES

Go to 5

5

Does appliance attempt ignition?

→ NO →

Pic 19



(yellow neon glowing front control box)

YES

Go to 6

(a) Check microswitch M2 (20v DC) is making contact and closed circuit (VCW only).

Pic 15

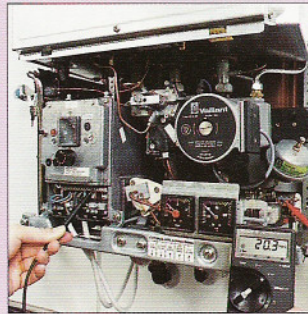

(b) Check fan pressure switch operates (240v AC from both sides of switch to neutral terminal 1) if not check C to F

Pic 16



(c) Check flue installation:

- Joints correctly located
- Flue not blocked
- Terminal position

(d) Check combustion chamber seals.

(e) Check air pressure switch tubes not blocked or kinked and small orifices in top cover plate clear.

Pic 17

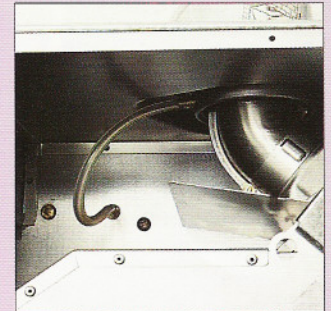

Pic 18

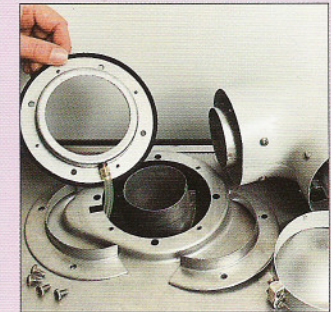

(f) Check fan working correctly.
If all above OK change fan pressure switch.

2

6

Does burner light and remain alight?

→ **NO** →

↓
YES
↓

Go to 7

N.B. For lockout (Black button & Red Neon) problems when no flame is visible check A to F.

Pic 20

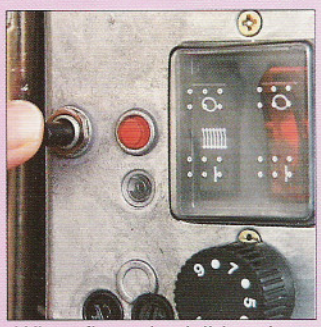

When flame is visible prior to lockout check F to H only
(a) Check gas supply to appliance live and purged.
(b) Check differential valve open (if no return to Q4).
(c) Check 20v DC across gas operator, if available but operator fails to open (audible click) change operator.

Pic 21

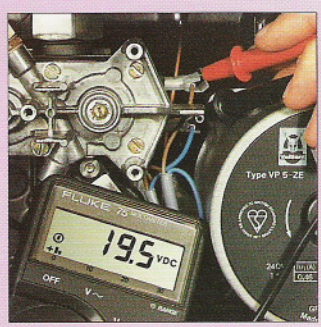

(d) Check central heating overheat thermostat and connection (should be closed circuit, if open change component).

Pic 22

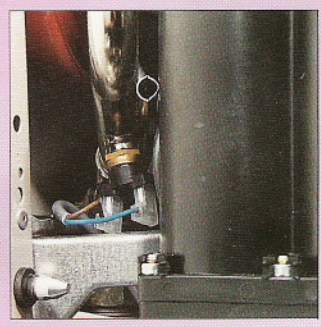

(e) Check spark generator, leads and electrodes.

Pic 23

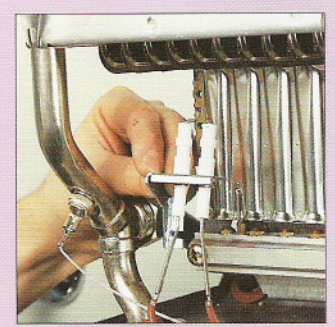

(f) Check ignition rate (gas burner pressure).

(g) Check flame monitoring electrode, lead and clean burner.

Pic 24

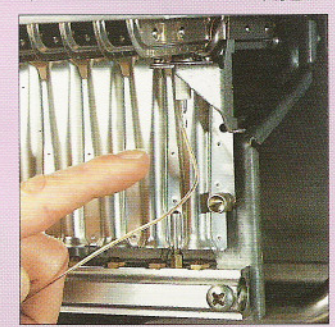

(h) Check flame stability (usually flue or gas burner pressure problems if unstable).

7

Does burner modulate up to high fire rate after approx 5 seconds ?

→ NO →

YES

Go to 8

(a) Check standing and working gas pressure at appliance inlet.

Pic 25

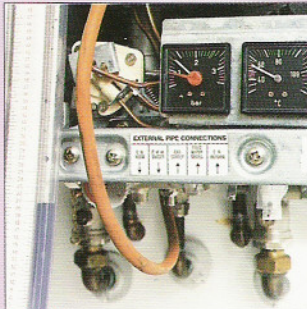

(c) Check voltage across diaphragm pump (approx 6v DC) with NTC disconnected.

Pic 27

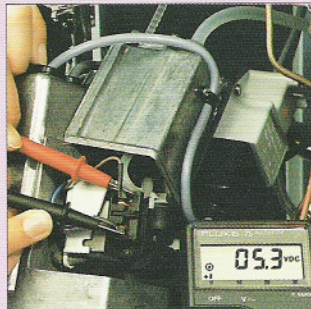

(b) Check diaphragm pump operating tubes and throttle jet clear.

Pic 26

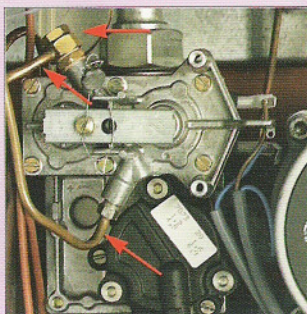

(d) Check burner pressure settings low and high fire rate.

Pic 28

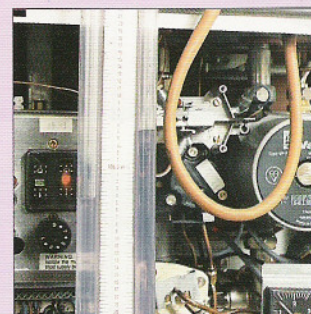

(e) Check and/or replace gas operator.

8

Does burner modulate down to low fire rate (ignition rate) and go off ?

→ NO →

To Test.

Put appliance thermostat to No6 , fire appliance for central heating. Burner should now modulate down and shut off at approx 60°C (see temperature gauge).

YES

If COMBIcompact VCW go to 9

If THERMOcompact VC
End of job

(a) Test NTC/Electronic board. Pull off NTC wire (from D.H.W. overheat) touch it on chassis, if burner goes off, change NTC.

Pic 29



If burner stays on change electronic board.

(The gas operator may be stuck open eg debris. This symptom is very unlikely but can be checked by pulling off the wire to operator. If burner remains alight then change operator).

2**9**

For VCW only - is D.H.W.
operation OK ?

NO**YES**

End of job

- (a) Check demand for hot water-tap open and supply pipes correct way round.
(b) Check water section moves servo valve cam - if not check venturi/diaphragm of water section.



Pic 30

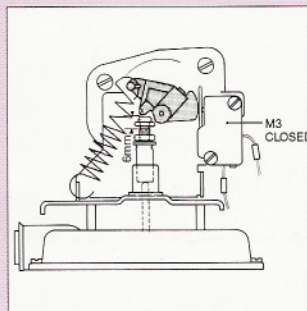

- (c) Check microswitch M3 (20v DC) is making contact and closed circuit.



Pic 31



- (d) Check hydraulic diverter valve moves right opening microswitch M1 (with M1 open no electrical continuity through switch).



Pic 32

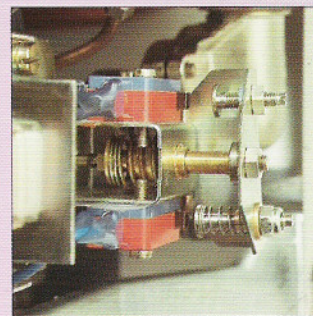

- (e) If DHW not hot enough check gas supply working pressure at appliance inlet & burner pressure. Refer to Pic 25 & Pic 28.

- (f) If water flow rate insufficient check for adequate cold water main supply and/or blockage in water section or DHW heat exchanger.

End of job.

Balanced Flue and Open Flue Models

COMBIcompact VCW221, 240, 280

THERMOcompact VC110, 180, 240, 221

Red Rocker switch - Set to ON position

Heating Switch - Set to ON position (VCW only)

Circulating Pump - Operating mode position one (I) (see guidance note 6)

First check central heating operation (All external controls on)

1

Can pilot light be lit and established ?

NO

YES

Go to 2

(a) Check gas supply to appliance live and purged.
(b) Check pilot injector, burner and supply tubes.

▼ *Pic 33*

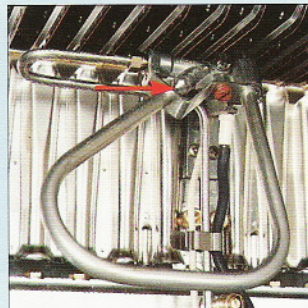

(c) Check piezo ignitor, leads and electrodes.

▼ *Pic 34*

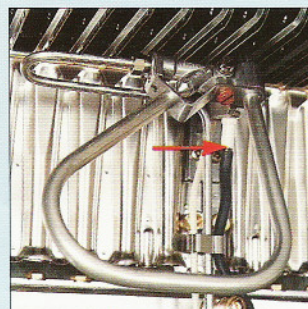

(d) Check thermocouple and connections .

▼ *Pic 35*

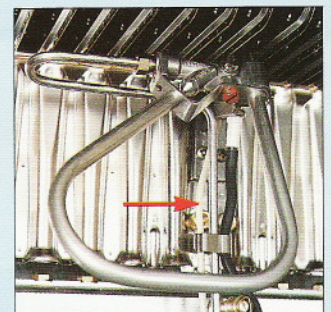

(e) Check central heating overheat thermostat and connections (should be closed circuit, if open change component).
Refer to Pic 22

(f) If intermittent pilot outage occurs check flue integrity (balanced flue) ventilation or draughts (open flue).

3**2**

Does red neon glow in main switch?

NO

(a) Check 240v AC across terminals 2 (L) and 1 (N)
Refer to Pic 1.

(b) Check 2 x 2 amp appliance fuses.
Refer to Pic 2.

(c) Check 3 amp spur fuse. If fuses OK and power available but neon fails to light, replace front Mother Board.

YES

Go to 3

3

Does pump run?

NO

(a) Check 240v AC across pump terminals (if not check C to F).
Refer to Pic 10.

(b) Check pump free to rotate and not stuck - If A & B are OK change pump.
Refer to Pic 11.

(c) Check 240v AC available for external controls at terminal 3, if not change Mother Board.
Refer to Pic 5.

(d) Check demand for heating - external controls on, and 240v AC back to terminal 4.

(e) Check anti surge fuse (0.16amp). *Refer to Pic 4.*

(f) Check safety isolating transformer 240v AC primary (black/grey) and approx. 17v AC secondary (brown/blue). *Refer to Pic 9.*

YES

Go to 4

4

Check hydraulic operation OK?

1. Hydraulic diverter valve moves left closes microswitch M2 (VCW only). Refer to Pic 13.
- or
2. Differential valve closes microswitch M4 (VC's only)

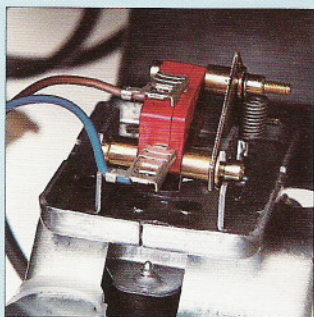

Pic 36

**NO**

(a) Check appliance and system full, pressurised and vented of air.

(b) Check servo valve is in C/htg position, return spring holds cam down (VCW only). Refer to Pic 12.

(c) Check differential valve and tubes.

(d) Check for dirt, flux sludge or inhibitor in system causing frothing affecting :-

1. Pump performance.
2. Hydraulic diverter valve (VCW only).
3. Servo valve (VCW only)
4. Connecting tubes.
5. Main heat exchanger.
6. Differential valve.

YES

Go to 5

3

5

Does burner light?

→ NO →

YES

Go to 6

- (a) Check variable potentiometer (boiler stat) setting on maximum.
- (b) Check appliance not in time delay (isolate power wait 5 seconds and restore).
- (c) Check Domestic Hot Water overheat thermostat (VCW only) - pull off bottom white wire, if burner lights - Replace DHW overheat. Refer to Pic 7.
- (d) Check NTC - (pull wire off NTC sensor, if burner lights change NTC. Refer to Pic 8.
- (e) Check operation and adjustment of microswitch M2 20v DC (VCW only). Refer to Pic 15.
- (f) Check differential valve closes microswitch M4 20v DC (VC only).

- (h) Check for continuity through gas section microswitch M5 (20vDC)

Pic 38

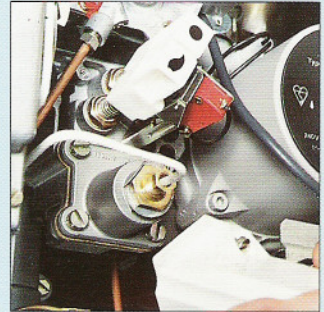

- (i) Check for continuity through main heat exchanger overheat thermostat.

Pic 39

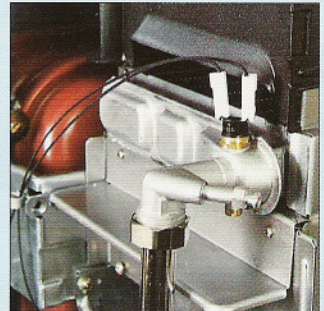

- (j) Check small p.c.b. bridge located bottom rear of Mother Board.

Pic 40

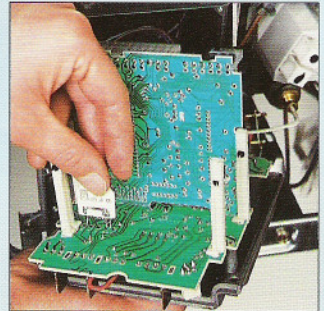

- (g) Check 20v DC across gas operator, if available but operator fails to open (audible click) change operator. Refer to Pic 21

Pic 37

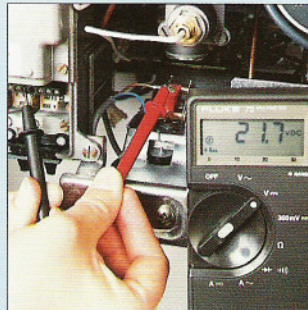

6

Does burner modulate up to high fire rate after approx 5 seconds?

→ NO →

YES

Go to 7

- (a) Check standing and working gas pressure at appliance inlet. Refer to Pic 25.
- (b) Check diaphragm pump operating tubes and throttle jet clear. Refer to Pic 26.
- (c) Check voltage across

diaphragm pump (approx 6v DC) (NTC disconnected Refer to Pic 27.

- (d) Check burner pressure settings low and high fire rate. Refer to Pic 28.

- (e) Check and/or replace gas operator.

7

Does appliance modulate down to low fire (ignition rate) and go off?

To test
Put appliance thermostat to no. 6, fire appliance for central heating. Burner should now modulate down and shut off at approx 60°C (see temperature gauge).

→ NO →

(a) Test NTC/Electronic board.

Pull off NTC wire (from DHW overheat) and touch it on chassis, if burner goes off change NTC.
Refer to Pic 29

If burner stays on change electronic board.

(The gas operator may be stuck open e.g. debris. This symptom is very unlikely but can be checked by pulling off the wire to the operator. If burner remains alight then change operator).

YES

If COMBIcompact VCW
Go to 8

If THERMOcompact VC
End of job

8

For VCW only - is D.H.W. operation OK?

→ NO →

(a) Check demand for hot water - tap open and supply pipes correct way round.

(b) Check water section moves servo valve cam - if not check venturi/diaphragm of water section. *Refer to Pic 30.*

(c) Check microswitch M3 (20v DC). *Refer to Pic 31.*

(d) Check hydraulic diverter valve moves right opening microswitch M1 (with M1 open no electrical continuity

through switch). *Refer to Pic 32.*

(e) If DHW not hot enough check gas supply working pressure at appliance inlet & burner pressure. *Refer to Pic 25 & Pic 28.*

(f) If water flow rate insufficient check for adequate cold water main supply and/or blockage in water section or DHW heat exchanger.

End of job.

YES

End of job

Head Office and Southern Region

Vaillant Limited, Vaillant House,
Medway City Estate, Trident Close,
Rochester, Kent ME2 4EZ

Reception Phone	0634 290155
Sales Phone	0634 292310
Sales Fax	0634 712804
Service Freephone	0800 318076
Service Fax	0634 294506
Technical Advice Phone	0634 292392
Technical Advice Fax	0634 294504
Training Phone	0634 292370

Vaillant Limited,

Area Training Centre
Littleton House, Ashford Road,
Ashford, Middlesex TW15 1UU

Service Freephone 0800 318076

Western Region

Vaillant Limited,

Dunster Road, Chelmsley Wood,
Birmingham B37 7UU

Sales Phone	021 788 3366
Sales Fax	021 779 7141
Service Freephone	0800 318076

Vaillant Limited, Unit 2,

Great Western Business Park,
Armstrong Way, Yate, Bristol BS17 5NG

Sales Phone	0454 321736
Sales Fax	0454 321622
Service Freephone	0800 318076

Northern Region

Vaillant Limited, Vaillant Building,

Euoway Trading Estate, Wharfedale Road,
Bradford, West Yorkshire BD4 6SR

Sales Phone	0274 688322
Sales Fax	0274 651096
Service Freephone	0800 318076

Vaillant Limited, Block 13, Unit 3,

Whiteside Industrial Estate, Factory Road,
Bathgate, West Lothian EH48 2RX

Sales Phone	0506 635522
Sales Fax	0506 636290
Service Freephone	0800 318076

2nd edition February '94

Designed and Produced by IMPACT Image Management 0622 721144

Vaillant cannot accept responsibility for damage as a result of non-observance of this Fault Finding Guide. Subject to alteration. (2/94).



HEATING, CONTROLS, HOT WATER.